

*spigo*compac®

SP

MOBILIARIO DEPORTIVO FENÓLICO: SPIGOCOMPAC
PHENOLIC SPORT FURNITURE: SPIGOCOMPAC

Spigo -

campac

Spigocompac, división de Spigogroup especialmente diseñada para ofrecer mobiliario deportivo y una amplia gama de productos técnicos multifuncionales fabricados en panel fenólico (cabinas, taquillas, bancos, encimeras, percheros, mamparas, etc.)

Spigocompac, division of Spigogroup specially designed to offer sport furniture and a wide range of multifunctional products (cabins, lockers, benches, tops, hooks, urinary spacers, among others.). These products are manufactured with phenolic panel.





Características

Characteristics

Spigocompac gracias a sus cualidades técnicas le ofrece un mundo de posibilidades en mobiliario deportivo con unas características idóneas capaces de adaptarse a cualquier proyecto, espacio y estilo deseado.

Spigocompac thanks to its technical attributes offers a world full of possibilities in sport furniture with ideal characteristics which are capable of adapting to any project, space and desired style.

Las excelentes propiedades de este tipo de material lo convierten en idóneo para ser instalado en diversos campos de aplicación tales como centros deportivos, gimnasios, hoteles, hospitales, edificios públicos y dotacionales.

Sus múltiples ventajas y beneficios lo han convertido en uno de los materiales más demandados por diseñadores y arquitectos.

The excellent properties of this material make it ideal for being installed on different application areas such as sport centres, gyms, hotels, hospitals and industrial and public buildings.

Its multiple advantages and benefits have made it one of the most demanded materials by designers and architects.



Reacción mejorada al fuego
Improved fire-reaction



Resistencia a la humedad
Moisture resistance



Resistencia a las manchas
Patch resistance



Resistencia al rayado/impacto
Scratch/impact resistance



Fácil mantenimiento
Easy maintenance



Antibacteriano
Antibacterial



Toda la gama de los productos Spigocompac están fabricados en panel fenólico de 12 mm.

Full range of Spigocompac products are produced in phenolic compact 12 mm.

FENÓLICO

Phenolic panel

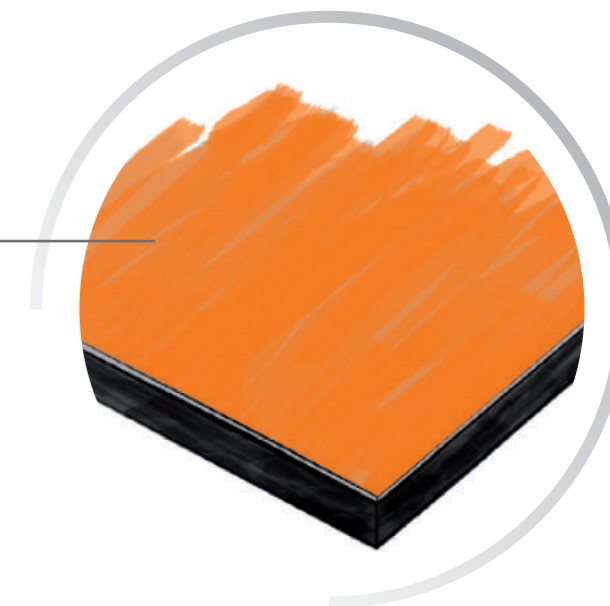



Acabados

Finishes

Spigocompac le garantiza contar con una amplia y variada gama de colores en stock y combinaciones inigualables, para conseguir unos resultados de excelencia en cada detalle.

Spigocompac ensures you a wide variety of range colours in stock and unique combinations to obtain excellent results in each detail.

GAMA DE COLORES EN STOCK STOCK RANGE OF COLOURS

	Rojo Red		Negro Black		Amarillo Yellow		Blanco White
	Verde Green		Azul Blue		Gris oscuro Dark Grey		Gris claro Light Grey

* Las muestras de colores impresas en este catálogo pueden presentar ligeras variaciones de color respecto a las terminaciones reales.
* The colour samples displayed in this catalogue can vary regarding the real endings.

OTROS ACABADOS OTHER FINISHES

Posibilidad de fabricar en cualquier otro acabado deseado, según proyecto y/o según indicaciones de la dirección facultativa.
There is possibility to manufacture any desired finish, according to project management's requirements.

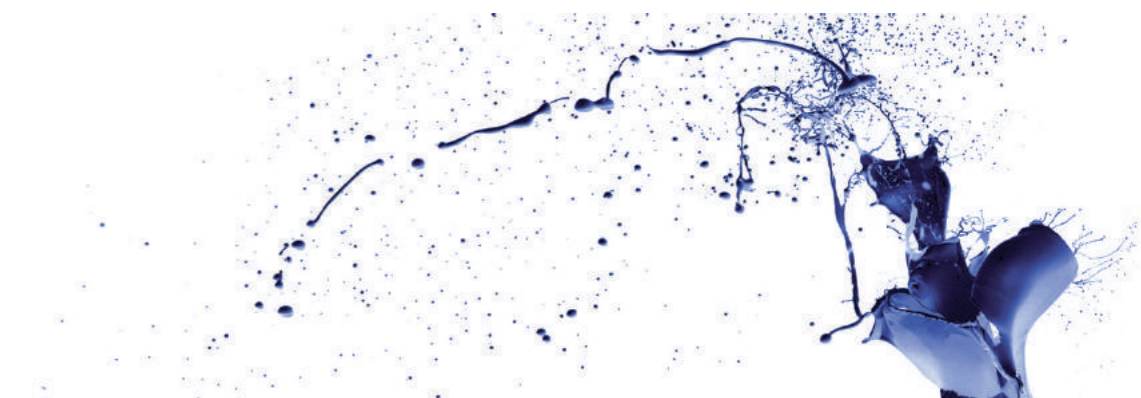



Las cabinas fenólicas o sanitarias son las soluciones más útiles y prácticas para realizar separaciones en las zonas de vestuarios. Su sistema de modulación unido a una estructura funcional de estética innovadora, facilita un mayor aprovechamiento del habitáculo y una preservación de la intimidad de los usuarios.

Phenolic cabins are the most useful and practical solutions to carry out partitions in lockers and toilets. Its system of modulation and functional structure with innovative aesthetic facilitates a greater advantage of the space in order to preserve customer privacy.

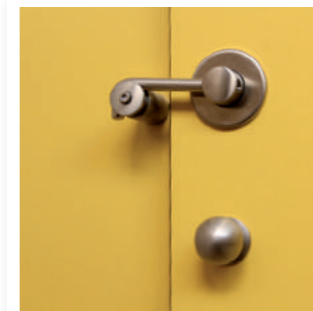

sp

Cabinas

Cabins



Spigocompac cuenta con una división de cabinas fenólicas diseñadas y fabricadas manteniendo unos rigurosos estándares de calidad y practicidad.

Spigocompac counts on phenolic cabin division which is designed and produced to maintaining strict quality standards.

MÓDULOS COMBINABLES COMBINABLE MODULES



Cabina simple
Simple cabin



Cabina doble
Double cabin



Cabina triple
Triple cabin



Especial puerta corredera
Sliding special door



Especial puerta adaptada
Adapted special door



Posibilidad de fabricar cualquier diseño y modulaciones combinables según proyecto.

There is possibility to produce any design and combinable modules under project.

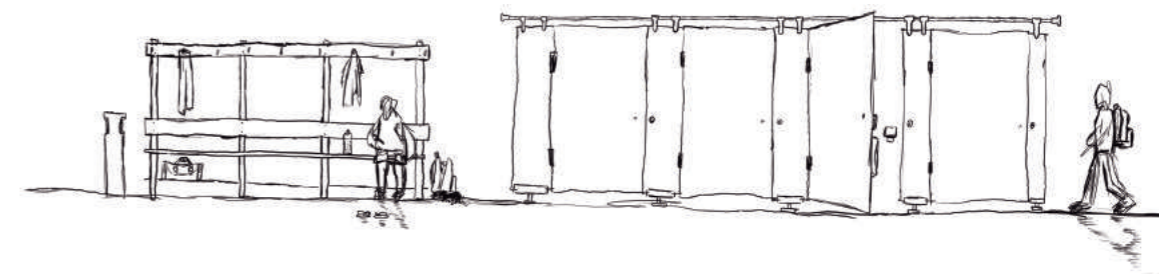



Las taquillas para vestuarios fabricadas en compacto fenólico se trata de un producto especialmente concebido para ser instalado en centros deportivos, gimnasios, hoteles, hospitales, centros lúdicos, industrias, etc. Disponen de un sistema de ventilación óptimo para cada compartimento y una gran variedad de colores, acabados y opciones de seguridad para que se adapten a las necesidades que sus instalaciones necesiten.

Lockers are made by phenolic compact panel. It is a product which is specially designed to be installed on sport centres, gyms, hotels, hospitals, recreational centres, industry, among others. These lockers have an optimum ventilation system for each compartment and a wide variety of colours, finishes and security settings so that are adapted to the requirements which the installations require.

TIPOS TYPES

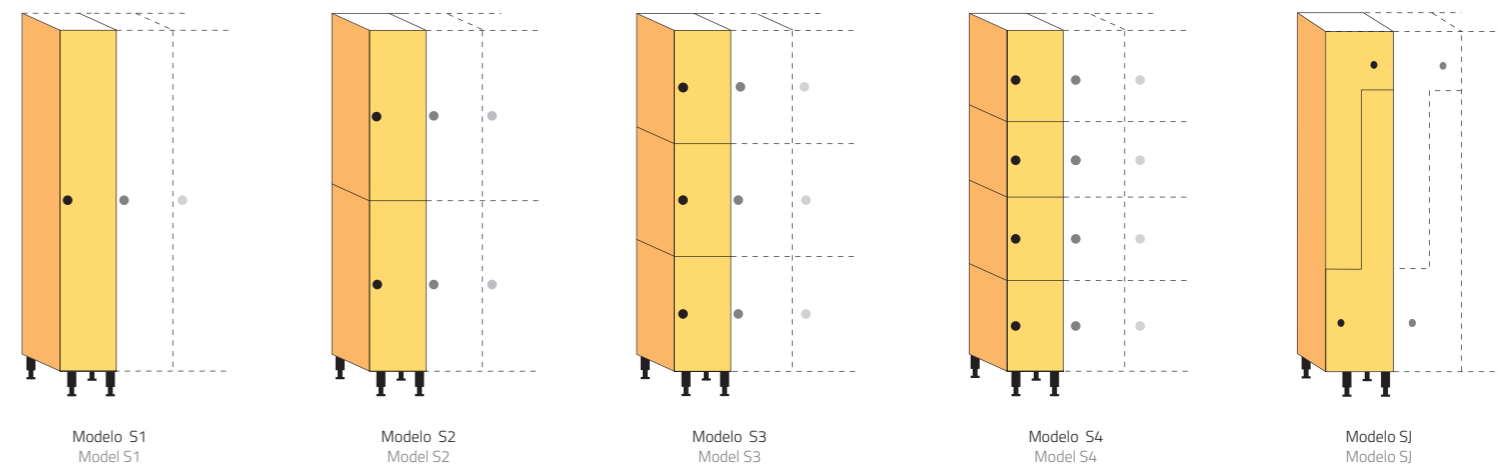

Modelo S1
Model S1

Modelo S2
Model S2

Modelo S3
Model S3

Modelo S4
Model S4

Modelo SJ
Modelo SJ

sp

Taquillas

Lockers

Spigocompac cuenta con una división de taquillas modulares que permiten alcanzar un mundo de posibilidades para elegir las que mejor se adapten a las necesidades que sus instalaciones necesiten.

Spigocompac has a modular lockers division which allows reaching a world of possibilities to choose the one to best fit the requirements which the installations require.

COMBINACIONES RECOMENDADAS POR EL FABRICANTE COMBINATIONS RECOMMENDED BY THE MANUFACTURER

		FRENTE (puertas) FRONT (doors)	
		Compacto Compact	Compacmel Compacmel
ARMAZÓN (laterales, tapa, base, baldas) BODY (Sides, covers, base, shelves)	Compacto Compact	•	
	Melamina Melamine	•	
	Compacmel Compacmel		•

Otras combinaciones consultar con el fabricante. If other combinations are required, please consult us.





Los bancos Spigocompac de estructura de aluminio permiten al usuario descansar y dejar sus pertenencias. Cuentan con una gran resistencia y funcionalidad en todas sus modalidades y existe gran diversidad de opciones combinables como parrillas, perchas, zapateros, respaldos...

Spigocompac benches with aluminum structure allow the user to rest and leave their possessions. These benches count on high resistance and functionality in all their modalities. Furthermore, there are a wide variety of combinable choices like shoe racks, hooks, respalds, etc.



MODELOS BANCOS ESTÁNDAR STANDARD BENCHES MODELS

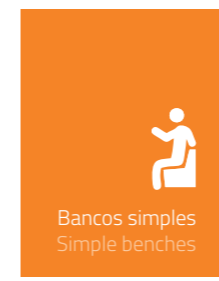

- BS-R1. Banco simple con zapatero, respaldo, perchero y balda superior.
BS-R1. Simple bench with shoe rack, back, rack and superior shelf.
- BS-R2. Banco simple con zapatero, respaldo y perchero.
BS-R2. Simple bench with shoe rack, back and rack.
- BS-R3. Banco simple con zapatero y respaldo.
BS-R3. Simple bench with shoe rack and back.
- BS-R4. Banco simple con zapatero.
BS-R4. Simple bench with shoe rack.
- BS-R5. Banco simple pared.
BS-R5. Wall simple bench.

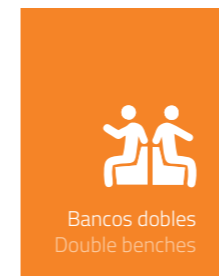

- BD-R1. Banco doble con zapatero, respaldo, perchero y balda superior.
BD-R1. Double bench with shoe rack, back, rack and superior shelf.
- BD-R2. Banco doble con zapatero, respaldo y perchero.
BD-R2. Double bench with shoe rack, back and rack.
- BD-R3. Banco doble con zapatero y respaldo.
BD-R3. Double bench with shoe rack and back.
- BD-R4. Banco doble con zapatero.
BD-R4. Double bench with shoe rack.



Bancos

Benches

Spigocompac cuenta con una división de bancos estandarizados con alta resistencia y funcionalidad, siendo capaces de adaptarse a los requerimientos específicos de cualquier tipo de instalaciones especiales.

Spigocompac holds a standardized benches division with high resistance and functionality, which are capable of adapting to the special requirements of all type of special installations.





Complementos

Complements

Spigocompac le permite la opción de elegir entre una amplia variedad de complementos disponibles que mejor combinen con la elección de sus productos técnicos multifuncionales.

Spigocompac allows choosing between a wide variety of available complements that combine and the election of its multifunctional technical products.

Para rematar el equipamiento de un proyecto que así lo requiere, le ofrecemos otros productos y soluciones especiales a medida que completan nuestra oferta y se ajustan a los diseños más demandados, buscando siempre acabados de calidad y diseños exclusivos.

Spigogroup offers you special custom solutions to conclude the equipment of a project requires it, which complete our offer and adjust to the most demanded designs. Spigogroup is always looking for quality finishes and exclusive designs.

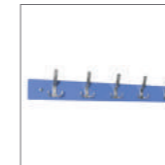

Perchero
Wall rack



Repisa
Shelf

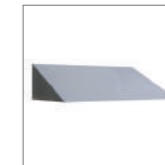

Techo inclinado
Pitched roof

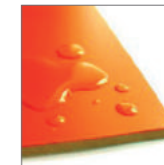

Encimera
Countertop



Revestimiento
Paneling



Separador
Spacers



Muñequera
Wristband
with key





Herrajes

Tools

Spigocompac le garantiza la confianza de contar con diferentes opciones de herrajes integrados que mejoren las prestaciones y especificaciones técnicas deseadas.

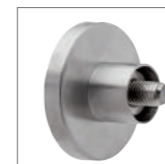
Spigocompac ensures the trust of having different choices of integrated fittings that improve the performances and desired technical specifications.

	Soporte suelo tablero Support tube panel		Puerta corredera Sliding door		Cerradura resbalón Latch lock		Cerradura moneda Coin lock
	Tubo cabina Cabin tube		Soporte tubo tablero Support tube panel		Soporte tubo pared Support tube wall		Pomo Door knob
	Conector Conector		Perfil "U" "U" profile		Muletilla con desbloqueo Unlocking toggle		Bisagra con/sin muelle Hinge with/no spring

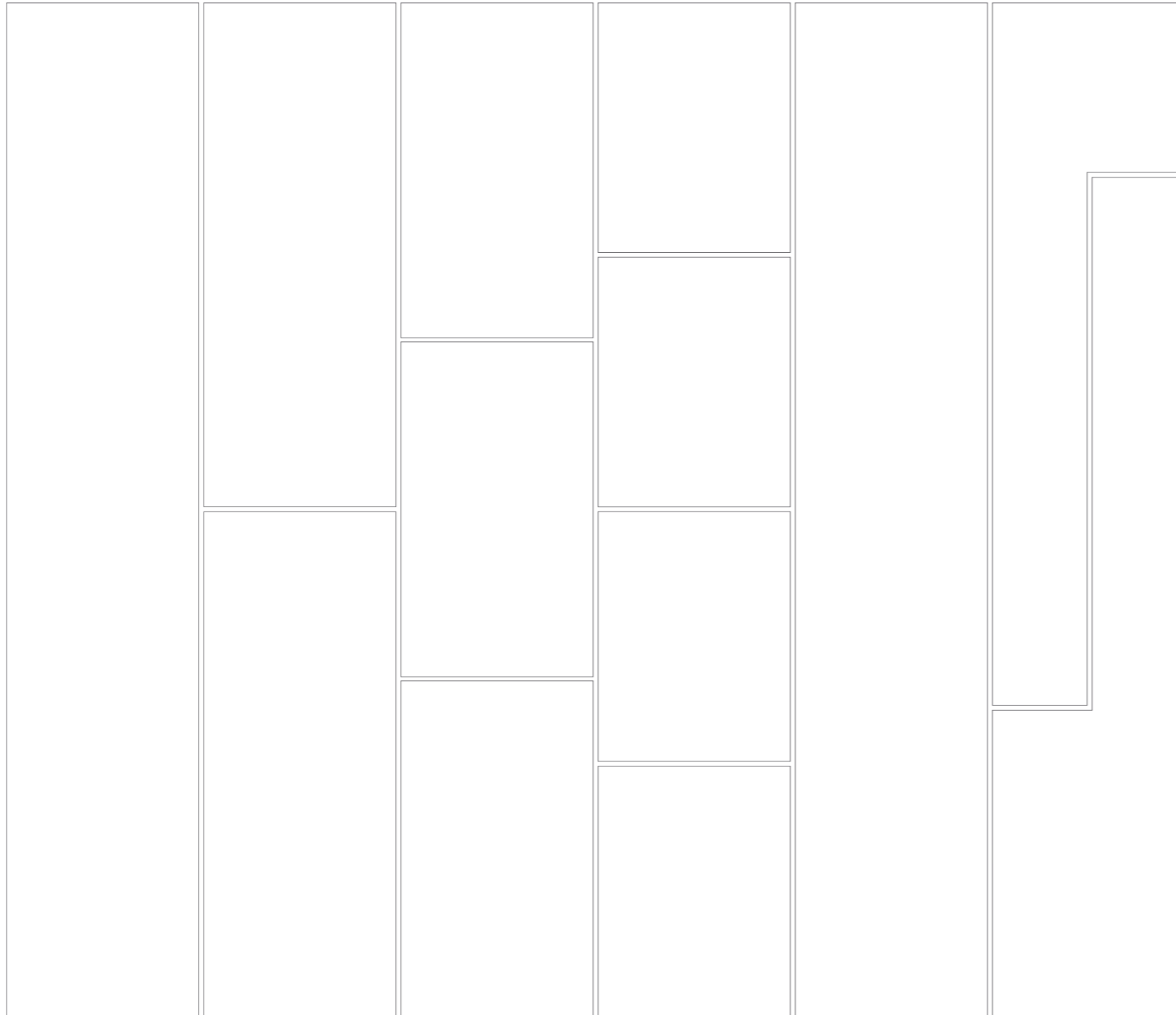

Características Characteristics

ACABADOS FINISHES

Rojo Red	Negro Black	Amarillo Yellow	Blanco White	Verde Green	Azul Blue	Gris oscuro Dark grey	Gris claro Light grey
-------------	----------------	--------------------	-----------------	----------------	--------------	--------------------------	--------------------------

Otros acabados, consultar. If others finishes are required, please consult us.

ESPESOR THICKNESS

El tablero compacto fenólico es un laminado de alta presión formado con varias capas de papel kraft prensadas a altas temperaturas formando un laminado. En el caso de Spigocompac de 12 mm de espesor.

Compact phenolic panel is high pressure laminate formed by some sheets of Kraft paper which are pressed at high temperatures to form a laminated, in case of Spigocompac, with 12 mm thickness.

ATRIBUTOS ATTRIBUTES

- Reacción mejorada al fuego
- Resistencia a la humedad
- Resistencia a las manchas
- Resistencia al impacto y al rayado
- Fácil mantenimiento
- Antibacteriano
- Improved fire-reaction
- Moisture resistance
- Patch resistance
- Resistance to scratches and impact
- Easy maintenance
- Antibacterial

PLAZOS DE FABRICACIÓN PRODUCTION DEADLINES	
Cabinas Cabins	3-4 semanas weeks
Taquillas Lockers	3-4 semanas weeks
Bancos Benches	3-4 semanas weeks

▲ Plazo exacto a la formalización del pedido.
Production deadlines will be given in a precise way, when the purchase order will be accepted.

PROPIEDADES PROPERTIES

Densidad ISO 1183 Density ISO 1183	1,35 g/cm³
Resistencia a la abrasión superficial EN 438-2, 10 Resistance to surface abrasion EN 438-2, 10	≥ 350 U
Resistencia al rayado EN 438-2, 25 Scratch resistance EN 438-2, 25	≥3 Newtons
Resistencia al impacto mediante caída de bola EN 438-2, 21 Resistance to impact (ball drop) EN 438-2, 21	≤10 mm
Resistencia a la flexión ISO 178 Resistance to bending ISO 178	≥ 80 MPa
Módulo de flexión ISO 178 Flexural Modulus ISO 178	≥ 9000 MPa
Resistencia al agrietamiento EN 438-2, 24 Crack resistance EN 438-2, 24	4
Solidez a la luz EN 438-2, 27 Lightfastness EN 438-2, 27	4-5 escala de grises grayscale
Índice de oxígeno ISO 4589-2 Oxygen value ISO 4589-2	≥45 %
Comportamiento al fuego Fire reaction	B-s2,d0
Resistencia a las quemaduras de cigarrillo EN 438-2, 30 Cigarette burn resistance EN 438 2-30	≥3
Resistencia inmersión en agua hirviendo EN 438-2, 12 Immersion boiling water resistance EN 438-2, 12	≤2,0 %
Resistencia al calor seco EN 438-2, 16 Resistance to dry heat EN 438-2, 16	≥4
Resistencia al calor húmedo EN 12721 Resistance to wet heat EN 12721	>4
Resistencia al vapor de agua EN 438-2, 14 Resistance to water vapor EN 438-2, 14	≥ 4
Resistencia al manchado EN 438-2, 26 Stain resistance EN 438-2, 26	≥ 4

Bancos Benches

Mod. BS-R1

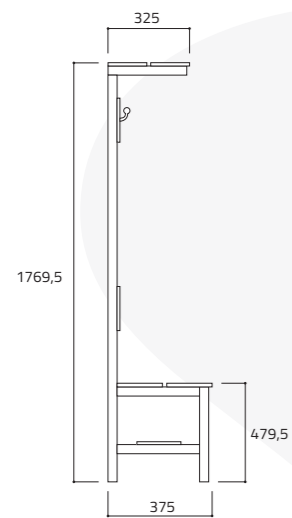

Mod. BS-R2

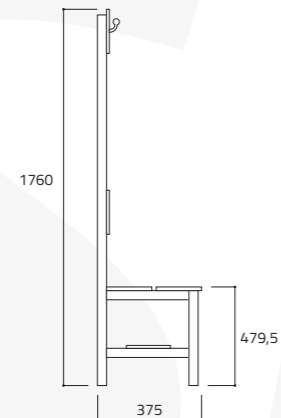

Mod. BS-R3

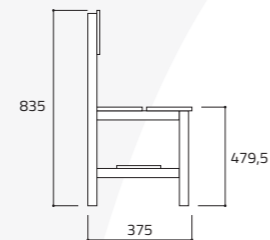

Mod. BS-R4



Mod. BS-R5

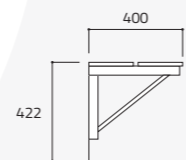

Mod. BD-R1

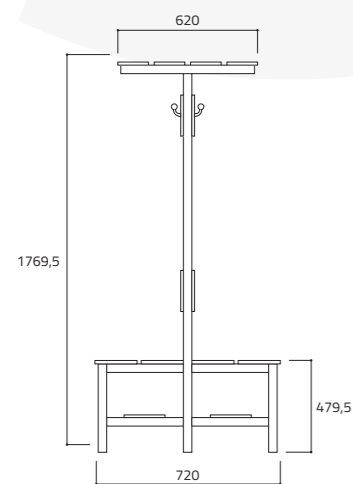

Mod. BD-R2

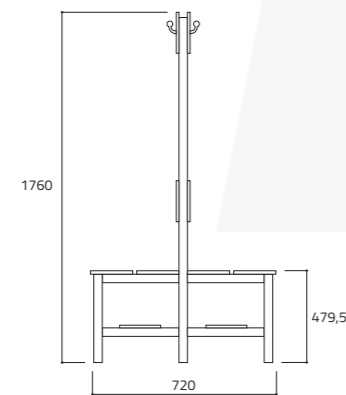

Mod. BD-R3

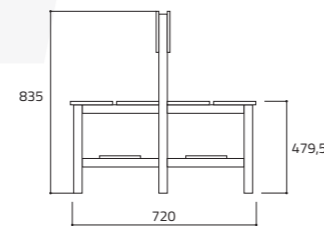

Mod. BD-R4

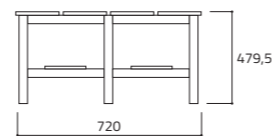

Taquillas Lockers

Mod. S1

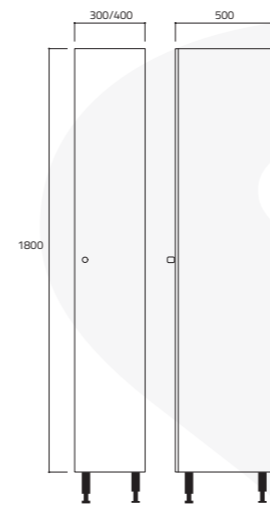

Mod. S2

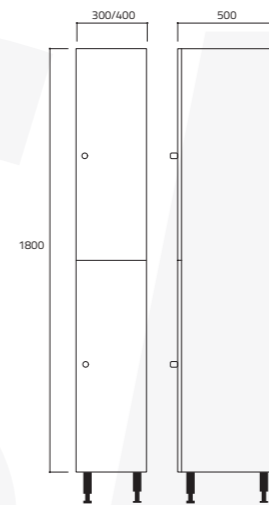

Mod. S3

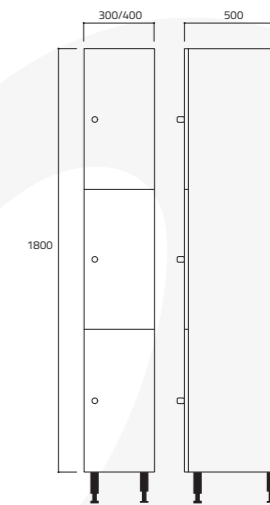

Mod. S4

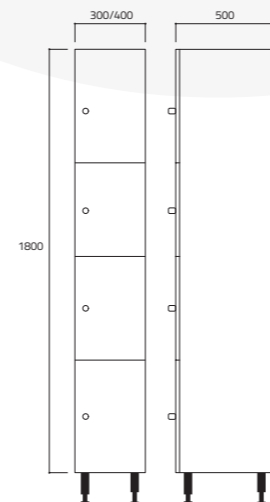

Mod. SJ

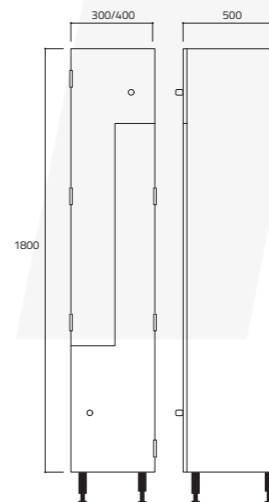

Estos modelos de bancos y taquillas son comunes en la mayoría de instalaciones y vestuarios por su estética y funcionalidad. Si por exigencia del proyecto estos modelos no se adaptan a sus necesidades, Spigogroup le ofrece la posibilidad de fabricar diseños exclusivos a medida.

These models of lockers and cabins are common in the majority of facilities and lockers rooms due to their aesthetic and functionality. If these models are not adapted to your project, Spigogroup is capable of manufacturing exclusive design on demand.

www.spigogroup.com

Cabinas Cabins

A la hora de solicitar un presupuesto formal para evitar errores y que no haya ningun problema es importante conocer bien cómo se toman las medidas de los planos, así como calcular los metros cuadrados necesarios para dar al fabricante y que no haya ningún problema. Desde Spigogroup, aconsejamos llevar a cabo los siguientes sencillos pasos:

When ordering, it is important to know very well how to take the drawing measures as well as calculate necessary square meter to give manufacturer and in this way, there will not be any problem. From Spigogroup, we advise on carrying out the following easy steps:

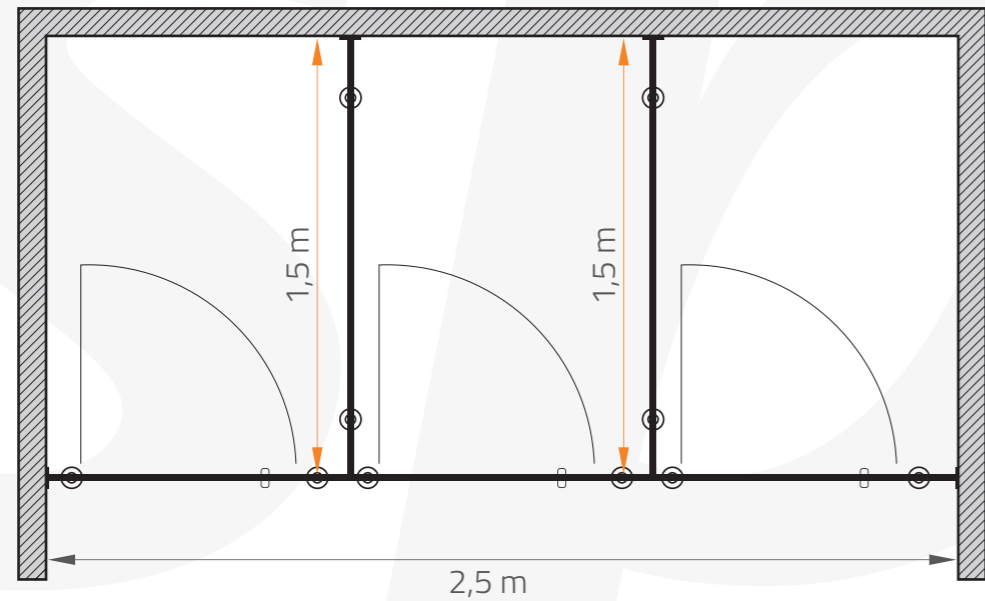

1

Véase el plano de la superficie disponible.
See the plan with available surface.

2

Marque las cotas de las cabinas.
Mark the dimensions of cabins.

3

Calcule los m² de la siguiente manera:
Ej. (2,5 m + 1,5 m + 1,5 m) x 2 m (*)
Calculate sqm of following way:
Ej. (2,5 m + 1,5 m + 1,5 m) x 2 m (*)

(*) 2 m es la altura de las cabinas Spigocompac. (*) Spigocompac cabin's has 2 meters of height.

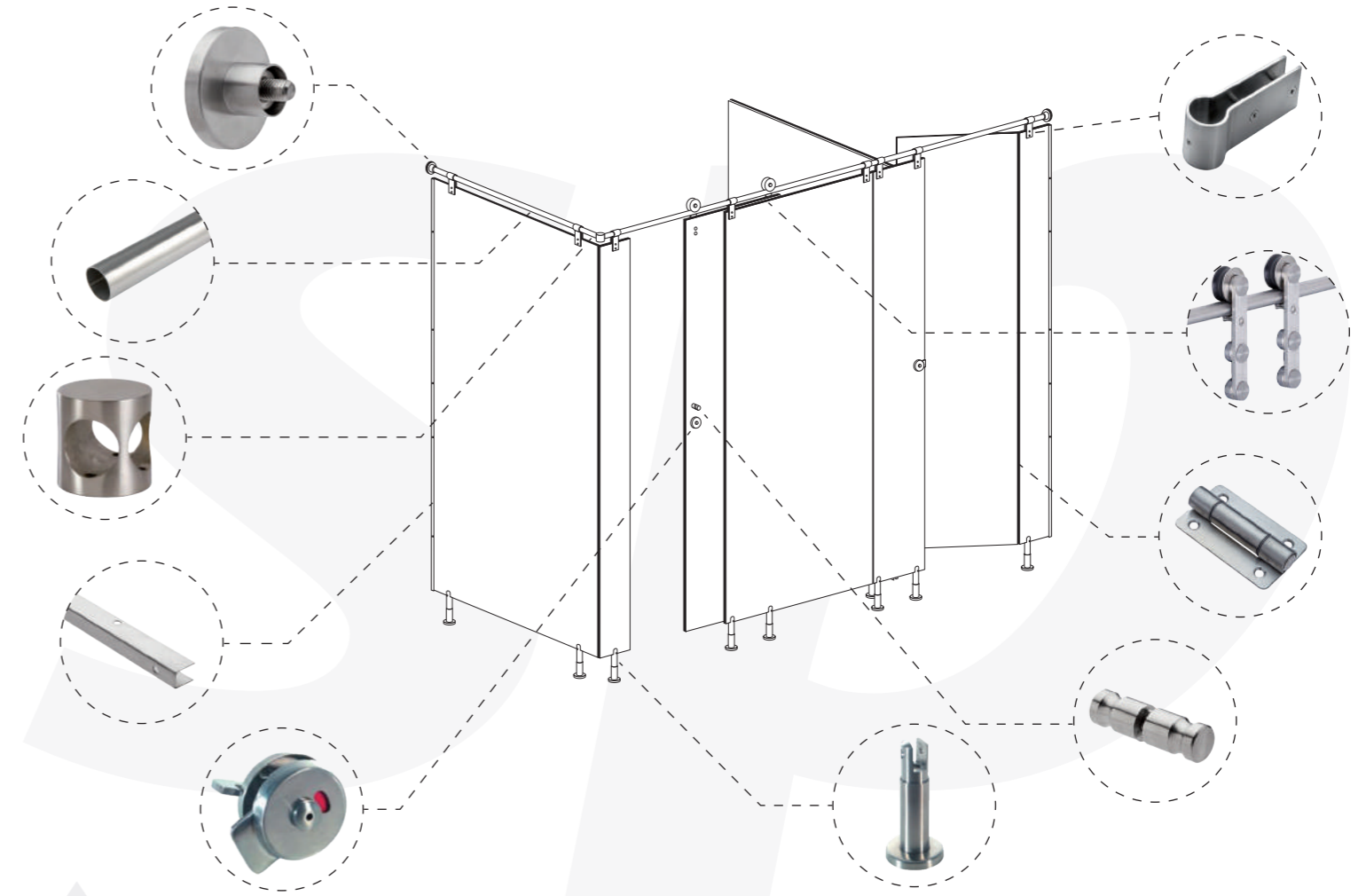

Todos los herrajes de las cabinas Spigocompac son de acero inoxidable AISI 304 garantizando la máxima calidad y durabilidad. Este tipo de herrajes son los más indicados para las aplicaciones dónde se requiere una gran resistencia a la corrosión, buena presencia y facilidad de limpieza.

All cabins' tools of Spigocompac are made of stainless steel AISI 304, ensuring the best quality and durability. This type of tools is the most recommended for applications in which great corrosion of resistance is required, good presence and easy to clean.

*Posibilidad de utilizar herrajes AISI 316 bajo pedido. *There is possibility to put AISI 316 fittings on request.

Áreas de aplicación Application areas

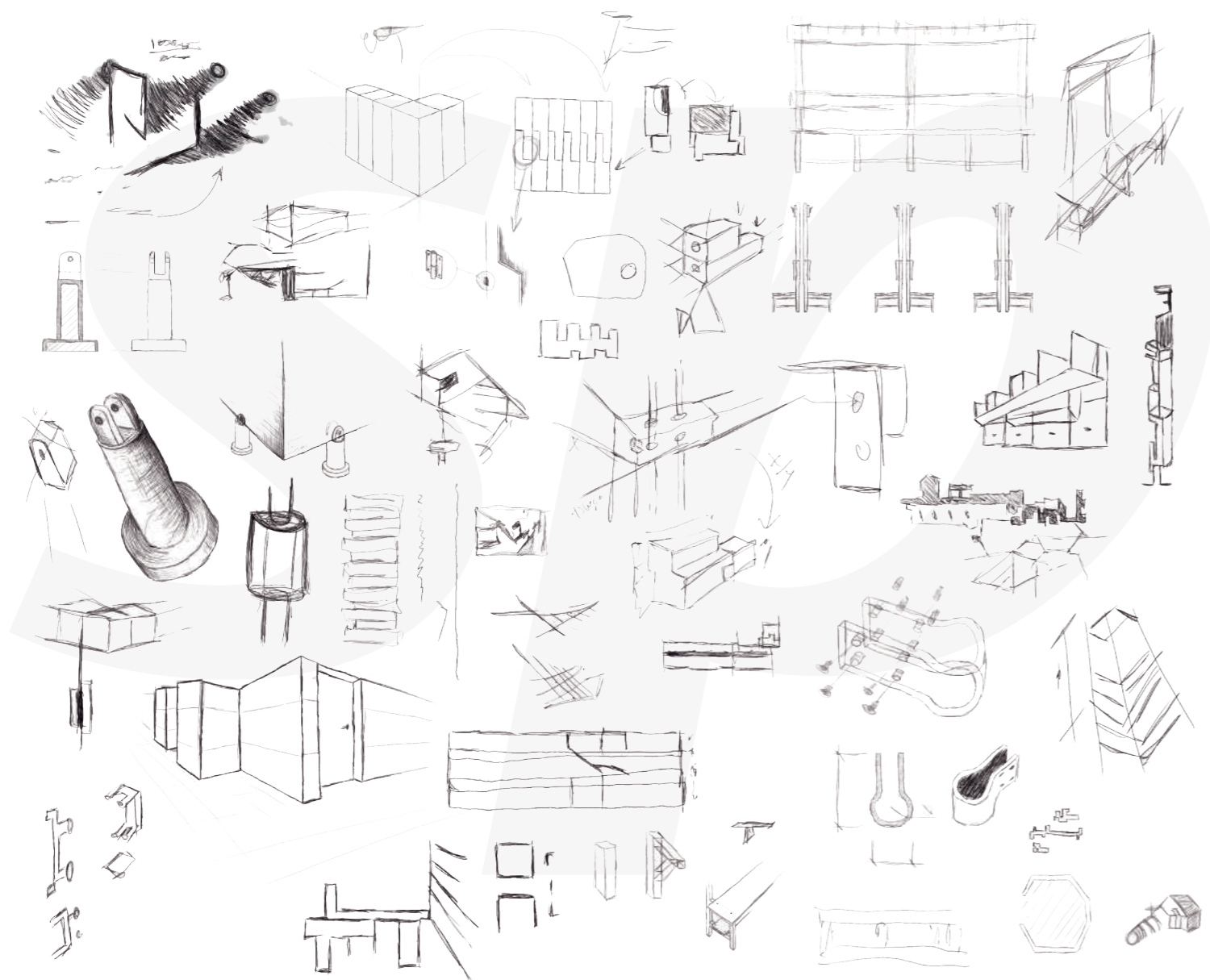

Centros de enseñanza

Aulas
Colegios
Guarderías
Universidades
Academias

Educational Establishments

Rooms
Schools
Nurseries
Universities
Academies



Usos múltiples

Salas de conferencias
Auditorios
Bibliotecas

Multiple applications

Conference rooms
Auditoriums
Libraries



Aeropuertos

Airports



Estudios de radio y TV

Radio & TV Studio



Iglesias

Churches



Edificios públicos

Public buildings



Restauración

Bares
Restaurantes
Hoteles

Restoration

Bars
Restaurants
Hotels



Salud

Hospitales
Centros de salud

Health

Hospitals
Health centres



Centros de ocio

Cines
Centros comerciales
Centros culturales
Teatros
Salas de conciertos
Ludotecas



Leisure Centre

Cinemas
Shopping centres
Cultural centres
Theatres
Concert halls
Play centre

Prescripción Prescription

Elegir **Spigocompac** representa tener la garantía de una calidad de servicio irreprochable. Profesionalidad, conocimientos técnicos y escucha para resolver lo mejor posible cualquier consulta constituyen nuestros principios fundamentales.

Pero elegir **Spigocompac** también significa beneficiarse de las numerosas ventajas de una firma con personalidad única e importante reputación:

-  Todos los productos Spigocompac combinan diseño y funcionalidad que contribuye a crear mejores condiciones y crear buenos ambientes interiores.
-  Las características y el embalaje de todos nuestros productos ofrece las mejores condiciones para el transporte, la manipulación y el almacenamiento.
-  Las excelentes propiedades del compacto fenólico con el que se fabrica Spigocompac lo convierten en idóneo para ser instalado en diversos campos de aplicación.
-  Están de conformidad con todas las certificaciones y normas vigentes que avalan la calidad de nuestros productos.
-  Cuentan con la mejor relación calidad-precio en un plazo inmejorable. Los acabados son perfectos y el resultado es impecable.

Para facilitar la elaboración de proyectos y la selección de nuestra gama de mobiliario deportivo **Spigocompac** ponemos a disposición de nuestros clientes la siguiente herramienta que apoyará su decisión de prescribir Spigogroup. Les permitirá localizar fácilmente la información que desean e incorporarla a sus presupuestos y planos.



ACCESO A PRESTO ACCESS TO PRESTO







- Información técnica Technical info.
- Planos Drawings
- Medidas Sizes
- Modelos Models
- Características Characteristics

Choosing **Spigocompac** means to have the guarantee of an irreproachable quality service. Professionalism, technical knowledges and listening to solve in the best way any request are our main principles.

But choosing **Spigocompac** also means to benefit from the advantages of a firm with unique personality and considerable reputation:

-  All Spigocompac products combine design and functionality, contribute to create better conditions and good interior circles.
-  The characteristics and packaging of all our products offer the best conditions for the transport, manipulation and storage.
-  Spigocompac is produced with phenolic compact panel whose excellent properties make it the perfect material to be installed in varied application areas.
-  Spigocompac panels accomplish all the certifications, homologations and existing rules which guarantee the quality of our products.
-  Spigocompac panels count on the price-quality ratio in an unbeatable deadline. The finishes are perfect and the result incredible.

To facilitate the elaboration of projects and the selection of our range of **Spigocompac** furniture products, Spigogroup put at customers' disposal the following tool which support with their decision to prescribe Spigogroup.

EJEMPLO TEXTO MEMORIA PROYECTO EXAMPLE TEXT MEMORY PROJECT

Suministro y colocación de cabinas gama SPIGOCOMPAC formadas por paneles compactos fenólicos de resinas termoendurecibles de 12mm. color liso a definir por la D.F. a base de frontales laterales e intermedios, puertas 600-800 mm. de anchura, altura de cabina 1800mm. + 150mm. (pies regulables) + 50mm. (conjunto pinzas-barra), consiguiendo una altura total de 2 metros. Separadores intermedios en diferentes medidas. i/pp de herraje necesario en acero AISI 304. Totalmente colocado y nivelado.

Supply and installation of Spigocompac cabins which are formed by phenolic compact panels of 12 mm thickness, plain colour to define by the Site Management with frontals, laterals and intermediates panels, doors of 600-800 mm width, maximum 2 meter high with 1800 mm (cabin) + 150 mm (regular toes) + 50 mm (set clamps-bar). Different dimensions of Intermediate spacers and necessary fittings in AISI 304 steel. Completely leveled and positioned.



Certificados Certificates

En la calidad final de un espacio constructivo también influye la gestión de la calidad en los procesos de producción. Por ello, Spigogroup desarrolla todos sus productos atendiendo a unos niveles de calidad que garanticen fiabilidad y confianza en todos sus proyectos.

Más de 30 años trabajando la madera han llevado a Spigogroup a respetarla, admirarla y ser conscientes de la importancia de establecer políticas para preservarla. Por ello, un excelente departamento de calidad dedicado a la mejora continua empresarial, avala su compromiso con el medio ambiente, el desarrollo sostenible de su actividad y su buena gestión empresarial como parte de la excelencia de sus productos y servicios.

The quality management in the production process influences in the final quality of a construction space. Therefore, Spigogroup develops its products to attend some standard of quality wich guarantee reliability and conficence into all projects.

Spigogroup has been working with wood over 30 years. Therefore, it has led us to admire and respect and be aware of the importance to stablish politics to preserve it. For this reason, an excellent Quality Department dedicated to the continuous business improvement, guarantees the commitment with the environment, sustainable development of its activity and its good business management like a part of excellence of its products and services.

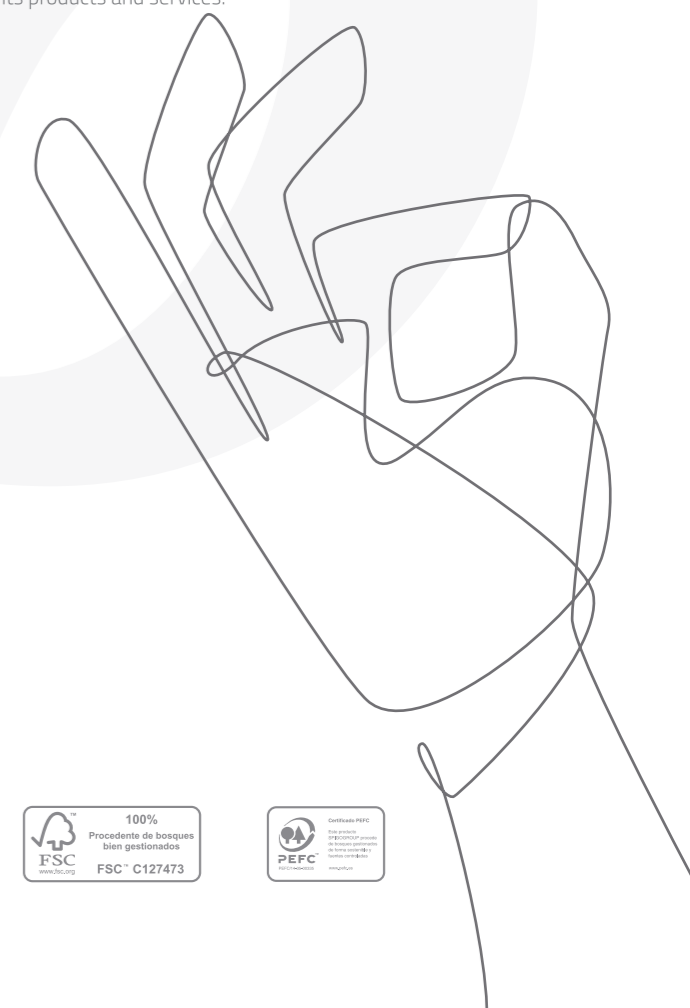

spigo GROUP[®]
PROYECTOS EN MADERA

Polígono Industrial Cantabria II
Calle Las Cañas 19
26009 Logroño, La Rioja, Spain
t. +34 941 244 777
f. +34 941 261 580
comercial@spigogroup.com
export@spigogroup.com
www.spigogroup.com

